

渦に注目するプラズマ宇宙物理の新展開

VORTEX in the Universe

吉田善章（東京大学・新領域）

Z. Yoshida (The University of Tokyo)

Collaborators:

The RT-1 Project (U. Tokyo)

S.M. Mahajan (U. Texas), P.J. Morrison (U. Texas),

R.L. Dewar (ANU) *et al.*

はじめに

- S.M. Mahajan & ZY, *Twisting space-time: Relativistic origin of seed magnetic field and vorticity*, PRL **105** (2010), 095005.
- プラズマ物理を「時空の問題」として考える.
- P. Cartier, *A mad day's work: from Grothendieck to Connes and Kontsevich, the evolution of concepts of space and symmetry*, Bull. Amer. Math. Soc. **38** (2001), 389. (Thank to 星野克道さん)

VORTEX: common “structure” in the Universe

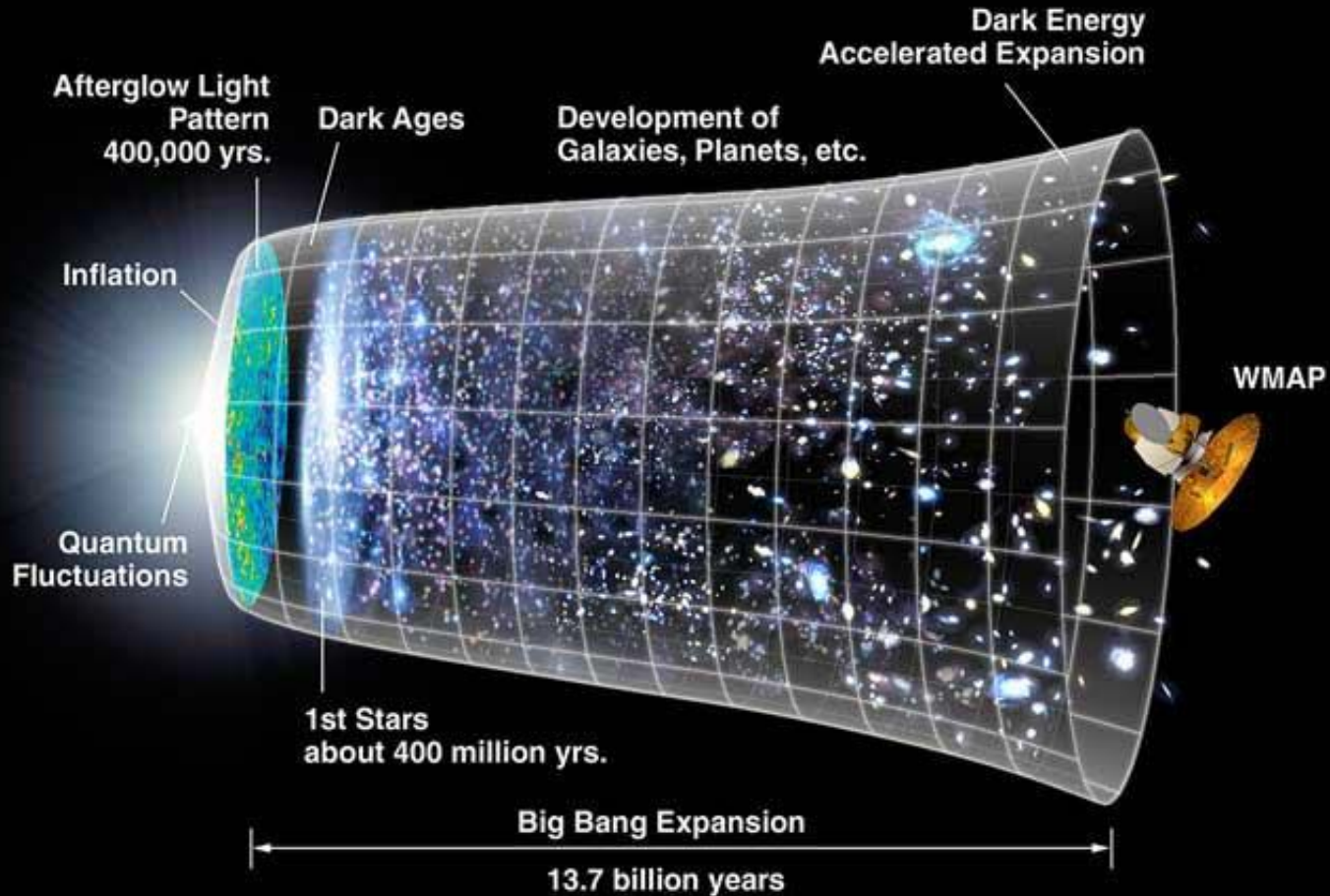

Cited from <http://www.astronomynotes.com/cosmolgy/s12.htm>

〈渦〉とコスモロジー(古典)

- **デカルト**: 「宇宙に充満する物質が渦巻運動の中で変容した結果、発光体である恒星群、光を伝える媒体となる微細物質、光を遮断する不透明体である遊星が分かれて生成し、また渦動が惑星と衛星を運ぶ」
- **ニュートン**: デカルトコスモロジーの批判
しかし、渦による物体運動の複雑化
- **オイラー**: 「エーテル中の幾つもの渦動」

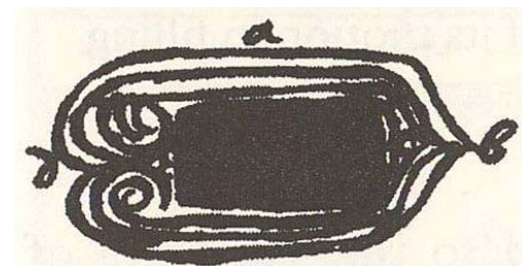

*Violent motion
(Newton's drawing).*

L. Euler 『惑星と彗星の
運動理論』(1744).

〈渦〉の物理・数理（近代～現代）

- 「渦度」による定式化

“curl” → 一般化：微分形式とホモロジー

- 「一般渦度」による統一化

$$\text{curl } \mathbf{P} = m\boldsymbol{\omega} + q\mathbf{B} + (dS_1 \wedge dS_2)/S_3 + \dots$$

- 「ヘリシティ」による数量化

→ トポロジー制約を与えるラグランジアン

- 「カシミール元」による幾何学化

→ 葉層構造

Is “vortex” a *thing*, *effect*, or *phenomenon*?

時空の歪みと渦 生成するもの・生成されるもの



Photo by K. Okano

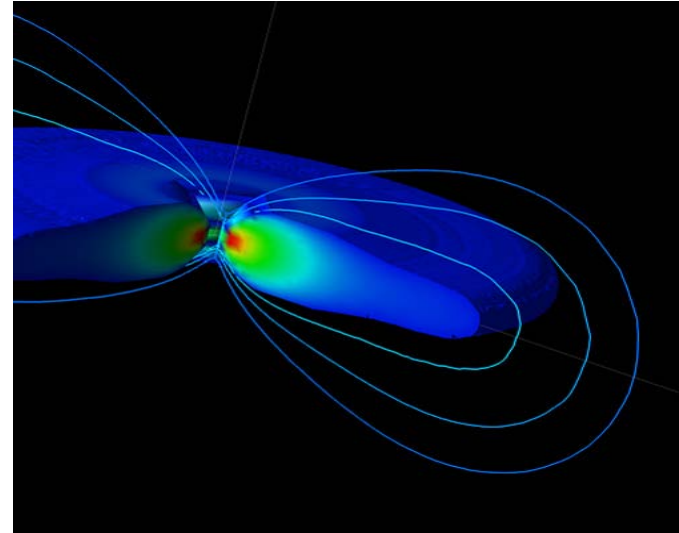

kurasse.jp/member/little-kinoko778/note/93577

Plasma physics as a problem of *space-time*

- Plasma = $L_{\text{matter}} + L_{\text{field}}$
- 〈渦〉を表現することの難しさ
 - Hamilton-Jacobi eq: $\mathbf{P} = \nabla S$
 - ◆ R. Jackiw, *Lectures on fluid dynamics--a particle theorist's view of super-symmetric, non-Abelian, noncommutative fluid mechanics and d-branes* (Springer, 2002).
 - ◆ Z. Yoshida & S.M. Mahajan, *Plasma Phys. Contr. Fusion* **54** (2012) 014003.
- 〈渦〉 = non-canonicity of symplectic geometry

Space-time: *a priori* of theory ?

- *Kopernikanische Wendung*
a priori of recognition
- space-time & matter
geometry & energy

$$\frac{d}{dt} F = [H, F]$$

[,] : geometry, H : energy

Mach: Space-time \leftrightarrow matter



Immanuel Kant
(1724-1804)

General syntax of Hamiltonian systems

- Hamiltonian mechanics is dictated by J (symplectic operator) and H (Hamiltonian)

$$\frac{d}{dt}u = J \partial_u H(u)$$

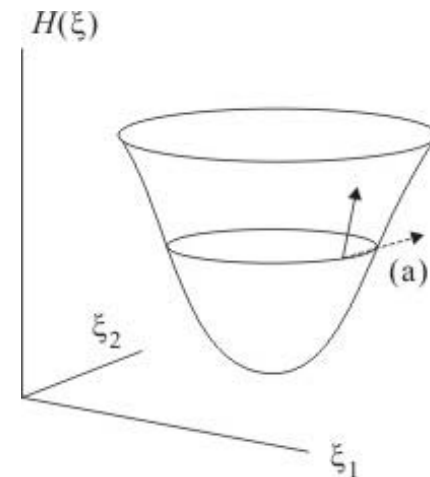

$$\text{Poisson bracket: } [G, F] = \langle J \partial_u G(u), J \partial_u F(u) \rangle$$

$$\frac{d}{dt}F(u) = [H, F]$$

$$[[F, G], H] + [[G, H], F] + [[H, F], G] = 0$$

Examples of Hamiltonian systems

classical mechanics:

$$\frac{d}{dt} \mathbf{z} = \frac{d}{dt} \begin{pmatrix} q \\ p \end{pmatrix} = \begin{pmatrix} 0 & I \\ -I & 0 \end{pmatrix} \begin{pmatrix} \partial_q H \\ \partial_p H \end{pmatrix} = J \partial_z H$$

quantum mechanics:

$$\partial_t \psi = -i \partial_\psi \langle \mathcal{H} \psi, \psi \rangle / 2 = J \partial_\psi H$$

These examples are “canonical” because J are regular operators.

non-canonical Hamiltonian mechanics

- $\text{Ker}(J) = \text{Coker}(J) \rightarrow$ “topological constraint” *
- Foliation of $\text{Ker}(J) \rightarrow$ Casimir elements

$$\exists C \text{ s.t. } [G, C] = 0 \ (\forall G)$$

i.e. $\partial_u C \in \text{Ker}(J)$

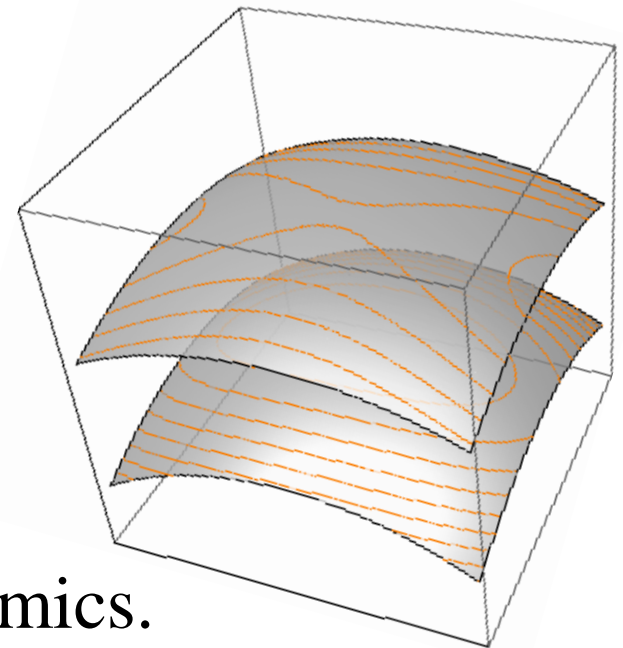

- $H \rightarrow H+C$ does not change the dynamics.

* $\text{Ker}(J\partial_z) = \text{Hom}_D(\text{Coker}(J\partial_z), F)$

The Euler eq. and vorticity eq.

- Euler equation of ideal fluid:

$$\begin{aligned}\partial_t u + (u \cdot \nabla)u &= -\nabla p, & \nabla \cdot u &= 0, \\ n \cdot u &= 0\end{aligned}$$

- Vorticity formulation:

$$\begin{aligned}\partial_t \omega &= \nabla \times (u \times \omega) & (\omega &:= \nabla \times u) \\ &= \{\omega, \phi\} & (2D : u &= \text{curl} \phi, \omega = -\Delta \phi)\end{aligned}$$

- *Vorticity eq. in $H^{-1}(\Omega)$ is equivalent to Euler eq. in $L^2_\sigma(\Omega)$.*

Hamiltonian formalism of the Euler eq.

- Hamiltonian formalism

$$\partial_t \omega = J(\omega) \partial_\omega H(\omega) \quad [\text{in } H^{-1}(\Omega)]$$

- Hamiltonian

$$H(\omega) = \frac{1}{2} \int_{\Omega} (K\omega) \cdot \omega \, dx \quad [K := -\Delta^{-1} : H^{-1}(\Omega) \rightarrow H_0^1(\Omega)]$$

- Poisson operator

$$J(\omega) = \{\omega, \cdot\} : H_0^1(\Omega) \rightarrow H^{-1}(\Omega)$$

$$[\psi, \varphi] = \langle J(\omega)\psi, \varphi \rangle := \langle \omega, \{\psi, \varphi\} \rangle \quad [\omega \in C(\Omega)]$$

- *Known to be classically solvable for a Hölder continuous initial value: T. Kato (1967)*

中間的まとめ (I)

- 渦 (ω) はメトリックである.
- 渦が規定するsymplectic幾何は非正準である.
Casimir element = $F(\omega)$
- 渦は渦の中で運動する. あるいは, 渦が運動する空間は渦によって構造が与えられている.
- MHDなども同様の構造をもつ.

Circulation theorem

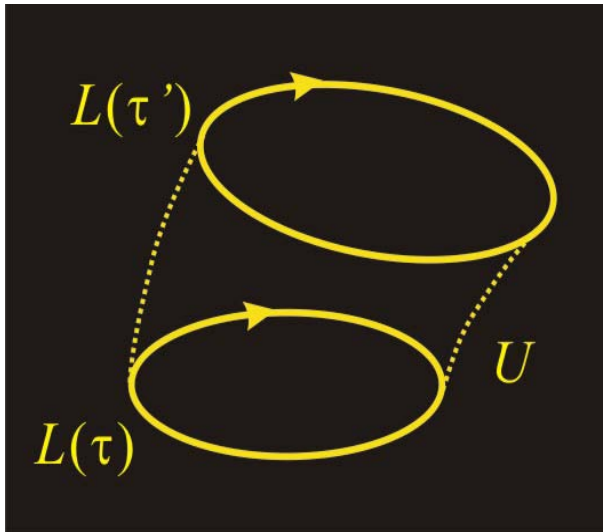

$$\frac{d}{dt} \left(\oint_{L(t)} \mathbf{P} \cdot d\mathbf{x} \right) = \oint_{L(t)} [\partial_t \mathbf{P} + (\nabla \times \mathbf{P}) \times \mathbf{V}] \cdot d\mathbf{x} = 0$$

if canonical momentum $\mathbf{P} = m\mathbf{V} + (q/c)\mathbf{A}$ obeys

$$\partial_t \mathbf{P} + (\nabla \times \mathbf{P}) \times \mathbf{V} = -\nabla \varphi \quad (\varphi = H + h).$$

Relativistic circulation theorem

$$\frac{d}{ds} \left(\oint_{L(s)} P^\mu \cdot dx_\mu \right) = \oint_{L(s)} (\partial^\mu P^\nu - \partial^\nu P^\mu) U_\nu dx_\mu$$

s : proper time, $U^\mu = (\gamma, \gamma V^j / c)$

relativistic equation of motion

$$(\partial^\mu P^\nu - \partial^\nu P^\mu) U_\nu = T \partial^\mu S$$

Relativistic circulation theorem applies on space-time:
relativistic distortion of space-time

→ non-exact thermodynamic force on the reference frame

→ Cosmological origin of vortex/magnetic field

Relativistic distortion of space-time

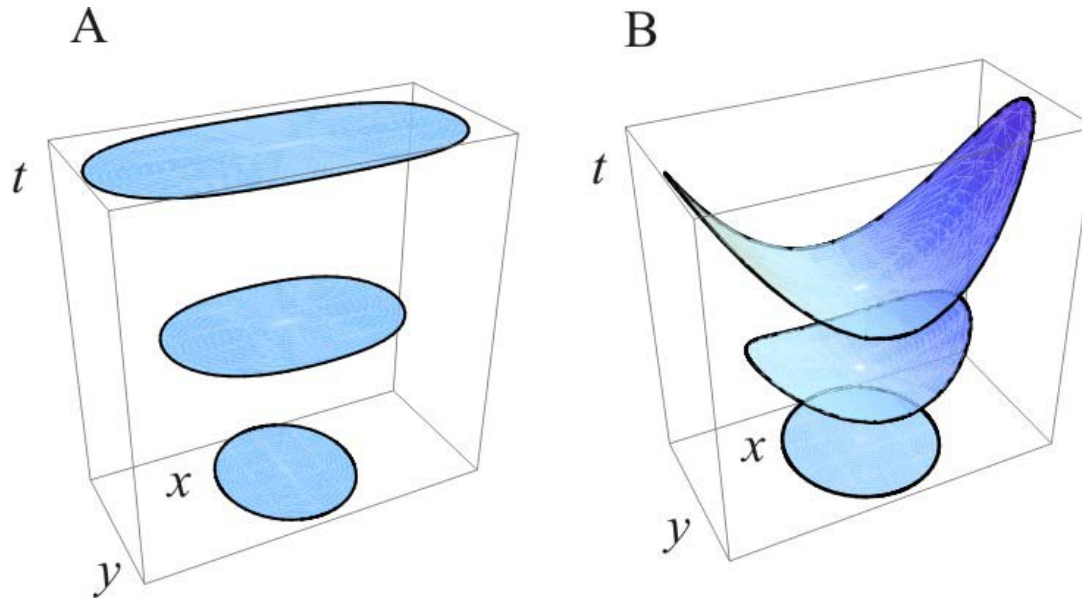

$$\frac{d}{dt} x_{\mu} = V_{\mu}$$

$$\frac{d}{ds} x_{\mu} = U_{\mu}$$

Relativity destroys the “synchronicity” of a cycle.

→ “twists” space-time

→ generate circulation

$$\oint_{L(t)} \gamma^{-1} T dS$$

scalar \rightarrow vector \rightarrow axial vector (vortex)

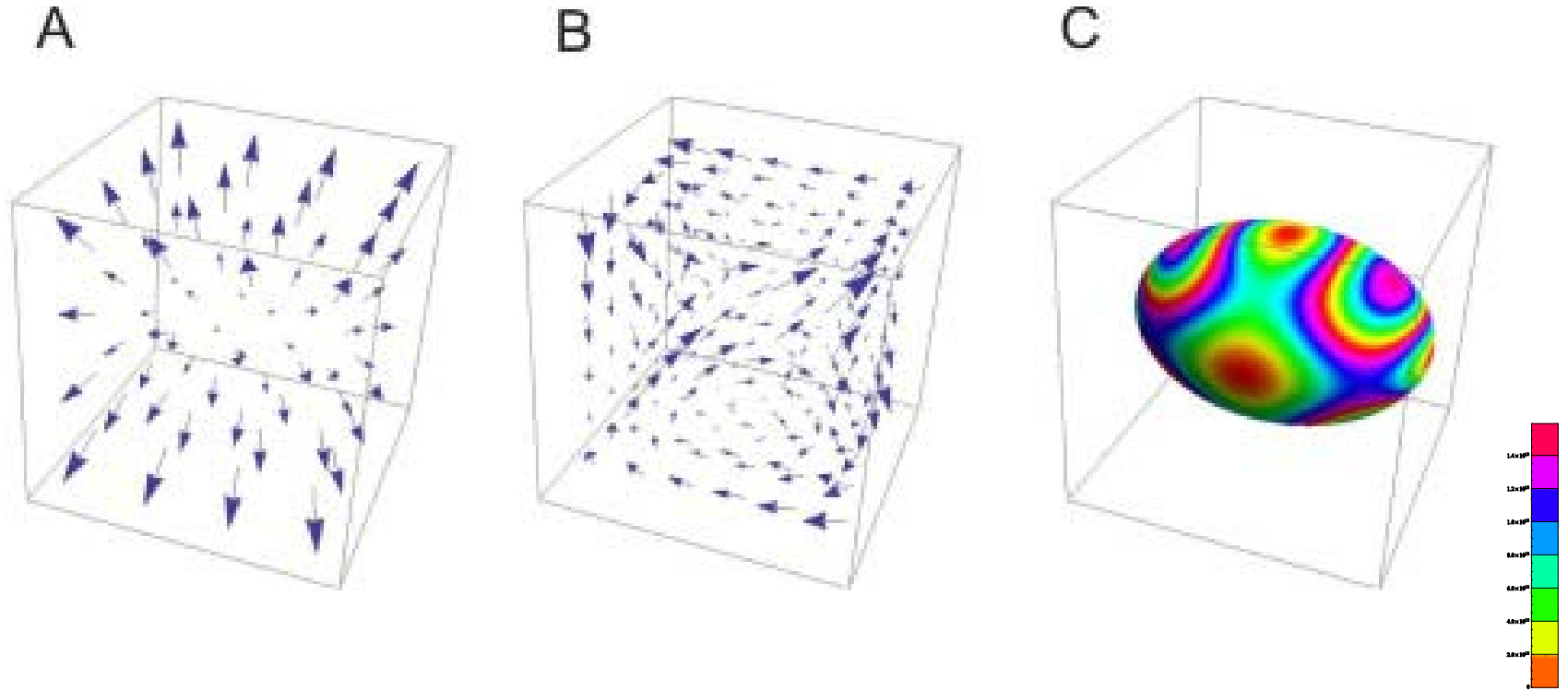

膨張



回轉運動



渦 = 磁場

中間的まとめ (II)

- Unification: vorticity + magnetic field
- Distortion \rightarrow Creation
- Non-exactness (entropy) \rightarrow Vorticity

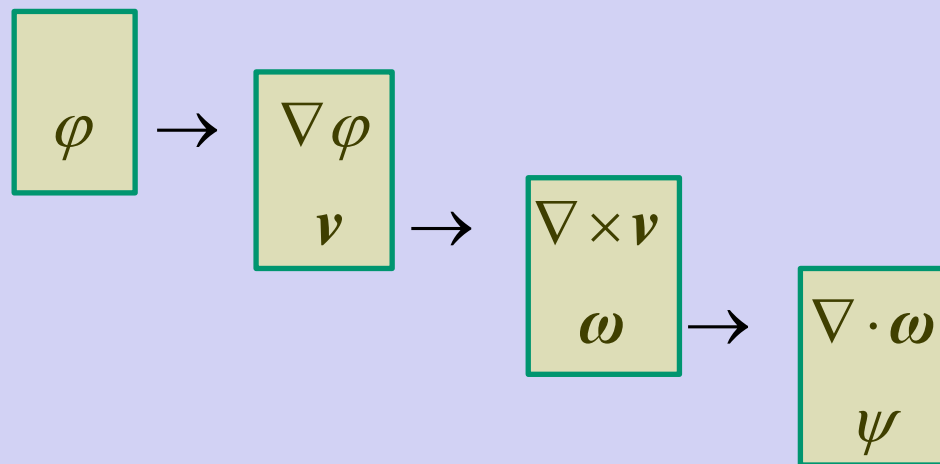

Distortion by *scale hierarchy*

- 構造形成とエントロピーの関係 ?
- 等分配の “measure” ?
- 「マクロ階層」の相空間 ?

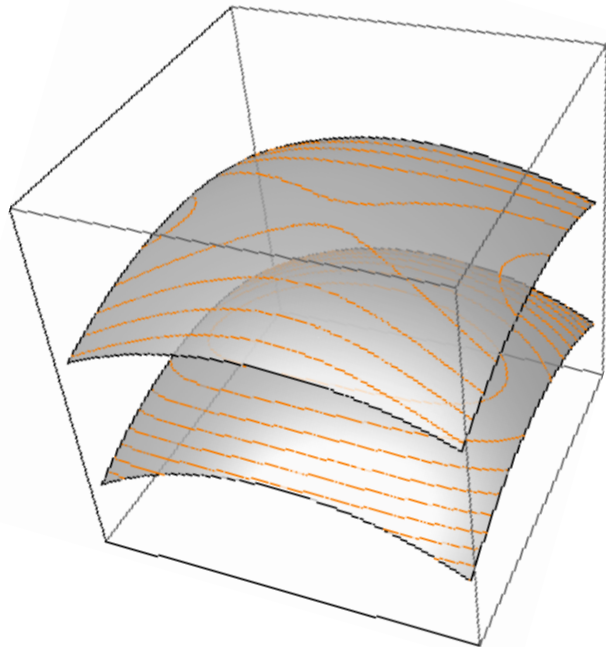

Image of constrained (foliated)
phase space

General Hamiltonian system

- Hamiltonian mechanics is dictated by J (symplectic operator) and H (Hamiltonian)

$$\frac{d}{dt}u = J\partial_u H(u)$$

$$\text{Poisson bracket: } [G, F] = \langle J\partial_u G(u), \partial_u F(u) \rangle$$

$$\frac{d}{dt}F(u) = [H, F]$$

$$\text{canonical form: } J = \begin{pmatrix} 0 & I \\ -I & 0 \end{pmatrix}$$

Non-canonical Hamiltonian mechanics

- Non-canonicity : $\text{Ker}(J)$

$$J = \begin{pmatrix} 0 & 0 & 0 \\ 0 & 0 & I \\ 0 & -I & 0 \end{pmatrix}$$

Effective phase space

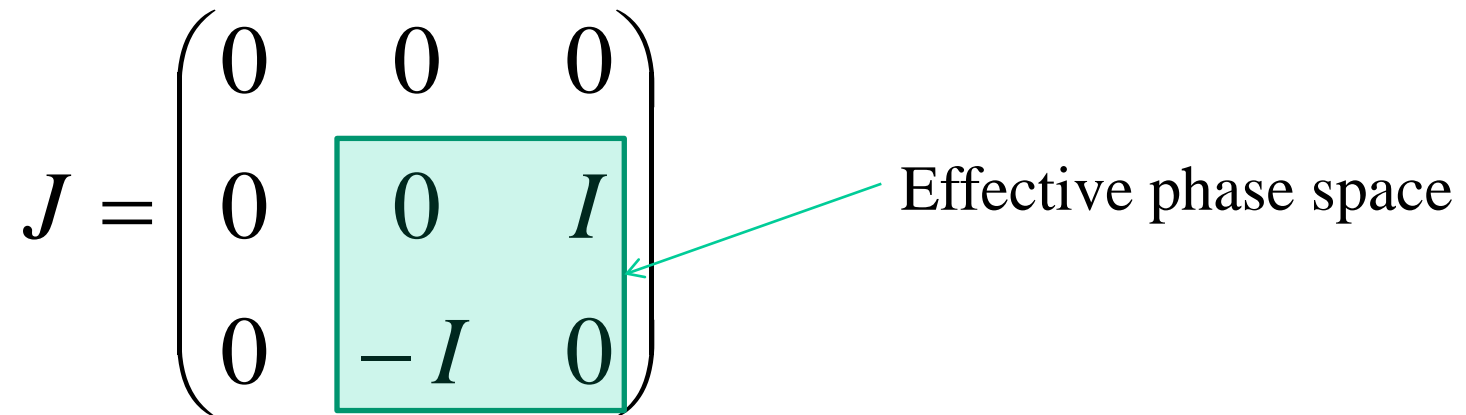

- $\text{Ker}(J) = \text{Coker}(J) \rightarrow$ “topological defect”

Scale hierarchy of magnetized particles

$$H = \frac{m}{2} (V_c^2 + V_{\parallel}^2 + V_{\perp}^2) + q\phi$$

$$\begin{aligned} H_c &= \mu\omega_c + \frac{m}{2} (V_{\parallel}^2 + V_{\perp}^2) + q\phi \\ &= \mu\omega_c + \frac{(P_{\theta} - q\psi)^2}{2mr^2} + \frac{p_{\parallel}^2}{2m} + q\phi \end{aligned}$$

$$z = (\mathcal{I}_c, \mu; \zeta, p_{\parallel}; \theta, P_{\theta})$$

“Quantization”

$$\mathbf{z} = (\mathcal{G}_c, p_c; \zeta, p_{\parallel}; \theta, P_{\theta}) \rightarrow (\cancel{\mathcal{G}_c}, \mu; \zeta, p_{\parallel}; \theta, P_{\theta})$$

Coarse-graining \rightarrow non-canonicalization

$$\mathbf{J} = \begin{pmatrix} J_c & 0 & 0 \\ 0 & J_c & 0 \\ 0 & 0 & J_c \end{pmatrix} \rightarrow \mathbf{J}_{nc} = \begin{pmatrix} 0 & 0 & 0 \\ 0 & J_c & 0 \\ 0 & 0 & J_c \end{pmatrix}$$

Boltzmann distribution on Casimir leaf

$$\delta(S - \alpha N - \beta E - \gamma M) = 0$$

$$S = -\int f \log f d^6 z$$

$$N = \int f d^6 z$$

$$E = \int H_c f d^6 z$$

$$M = \int \mu f d^6 z$$

$$f = c \exp(-\beta H_c - \gamma \mu)$$

Chemical potential

Quasi-particle number

Embedding into the lab-frame space

$$\begin{aligned}\rho(x) &= \int f d^3v = \int f (2\pi\omega_c / m) d\mu dv_{\parallel} dv_{\theta} \\ &= c \int \exp(-\beta H_c - \gamma \mu) \frac{2\pi\omega_c d\mu}{m} dv_{\parallel} dv_{\theta} \\ &= \frac{\omega_c(x)}{\omega_c(x) + \gamma}\end{aligned}$$

Density clump in lab-frame space

Adiabatic invariant μ

→ *quantization* of quasi-particles

→ thermodynamic distribution on a Casimir leaf

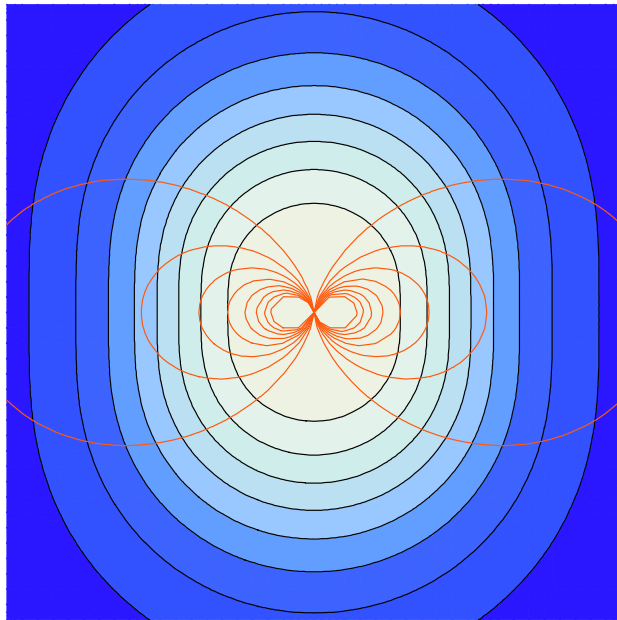

(A)

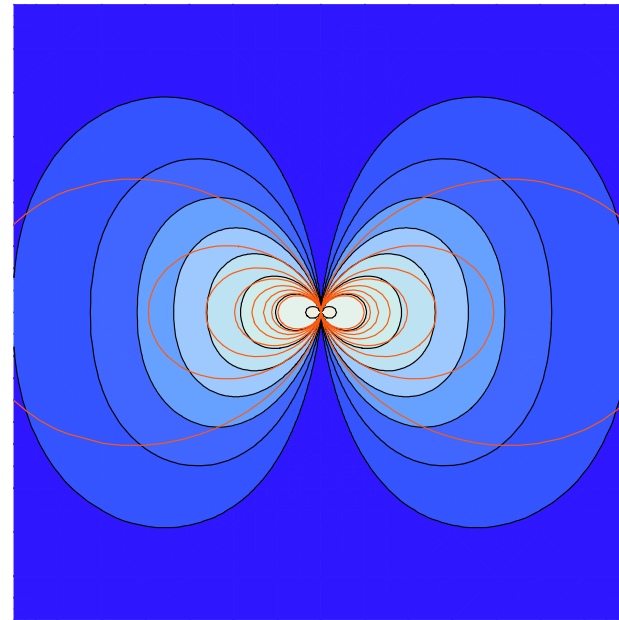

(B)

中間的まとめ (III)

- スケール階層 = 相空間の葉層構造
- 断熱不変量 = *Casimir element* → 葉層
- 葉層上の歪んだメトリック → 自己組織化

A magnetosphere on the Earth

RT-1 project

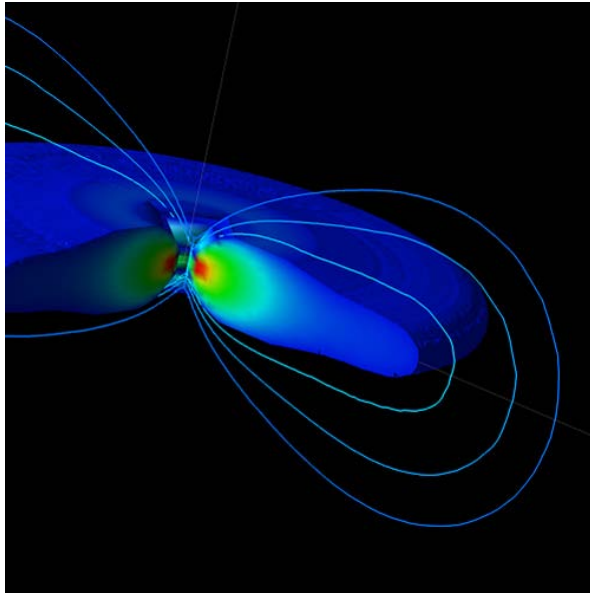

Jovian magnetosphere

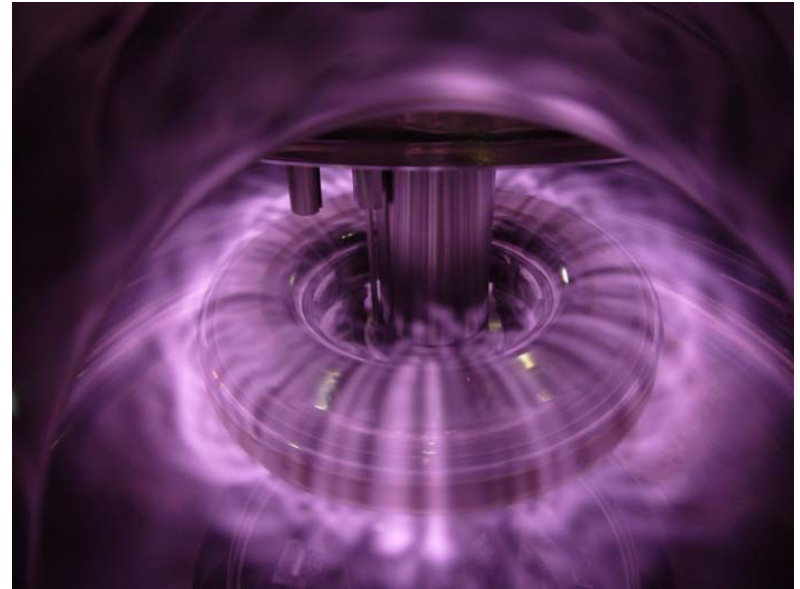

RT-1 magnetospheric plasma

Levitating HTC superconducting magnet system

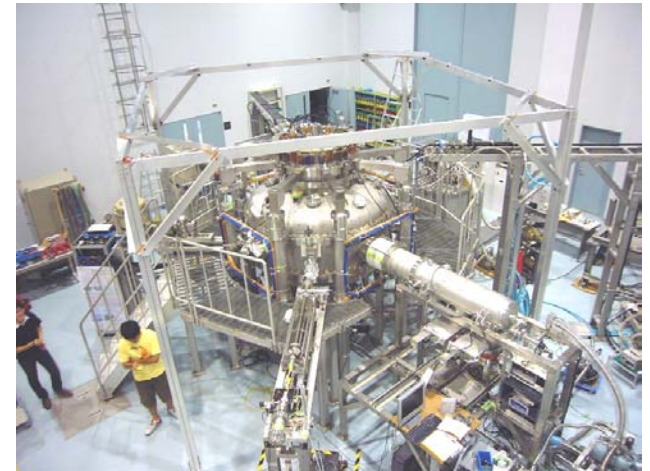
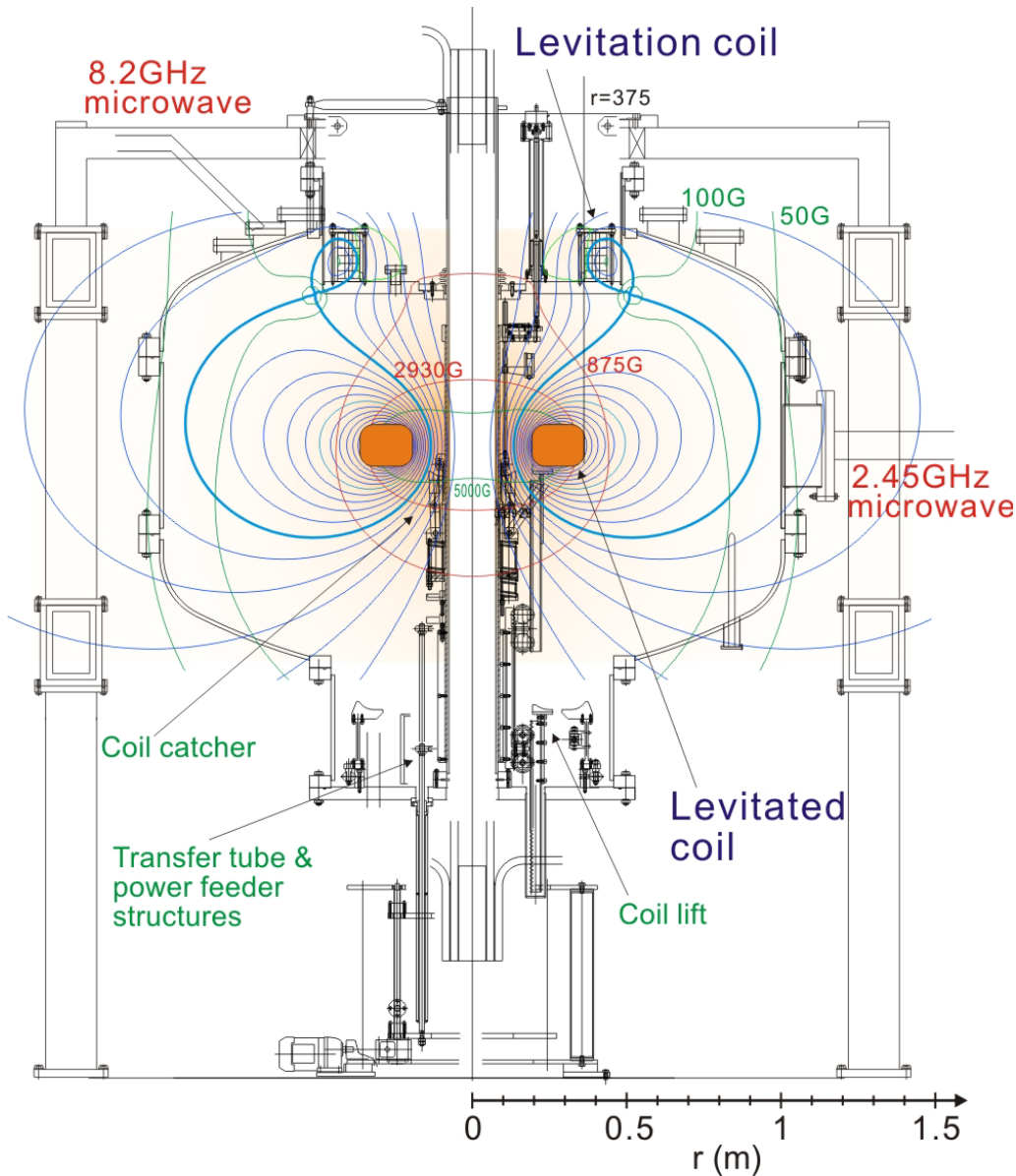

High-beta plasma confinement

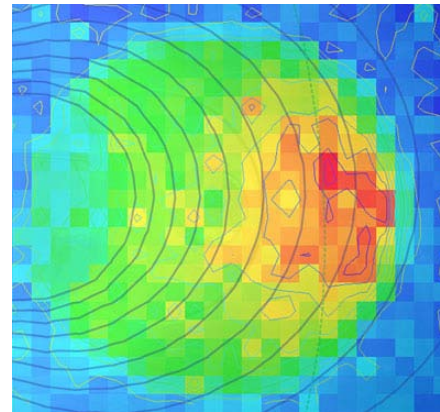
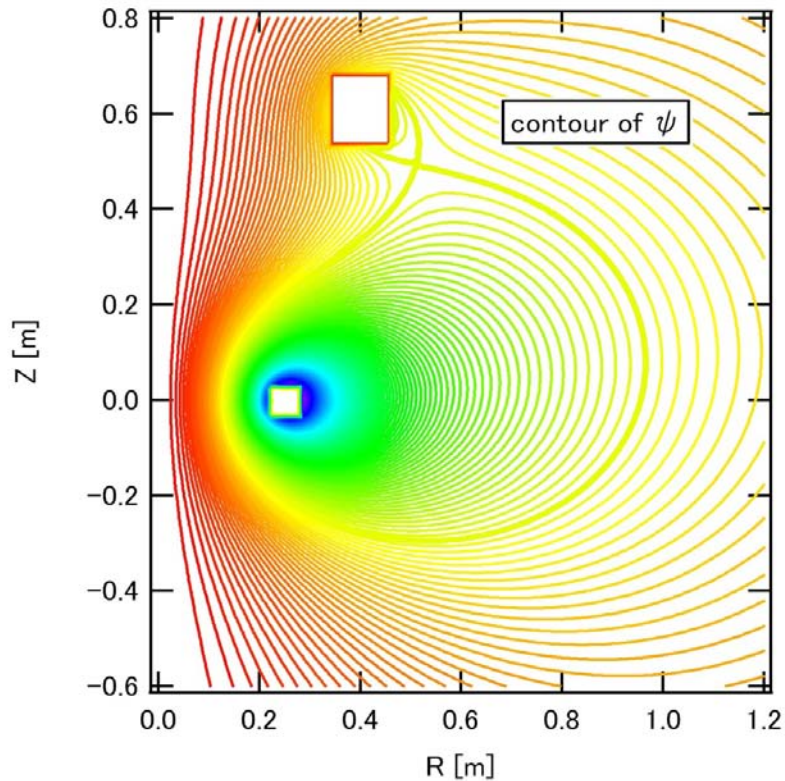

$$T_e \approx 10 \sim 30 \text{ keV}, \quad n_e = 10^{16} \sim 10^{17} \text{ m}^{-3}$$

$$\beta \approx \beta_e \approx 0.7, \quad \tau_E \approx 0.5 \text{ sec}$$

Creation of magnetic moment by heating

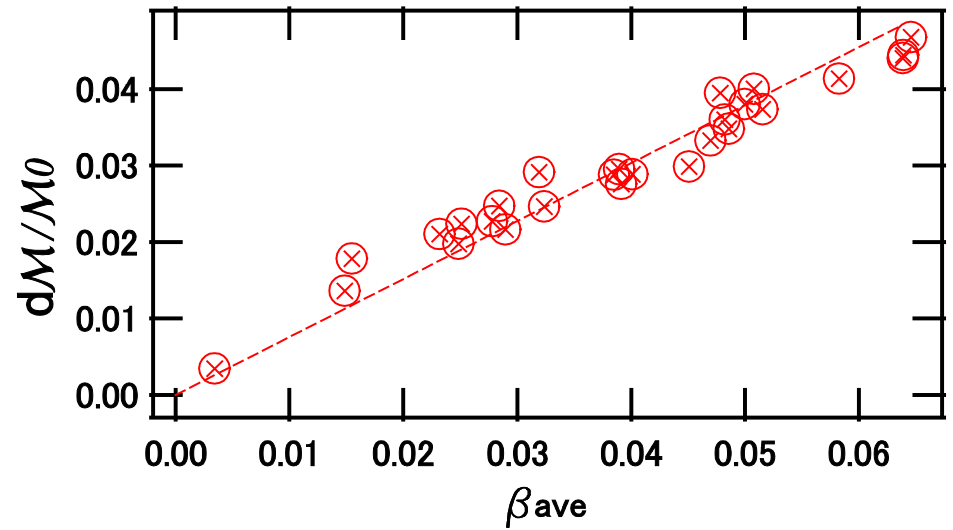
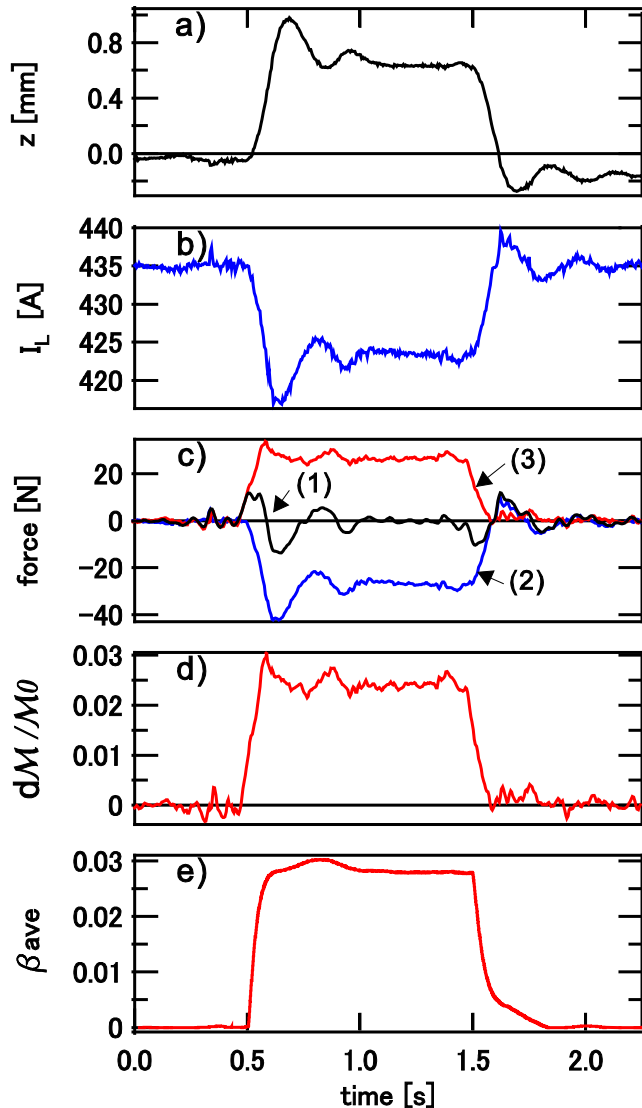

$$\delta Q_{\text{ECH}} = \bar{B} dM = \bar{B} \sum_j d\mu_j$$

Inward (up-hill) diffusion

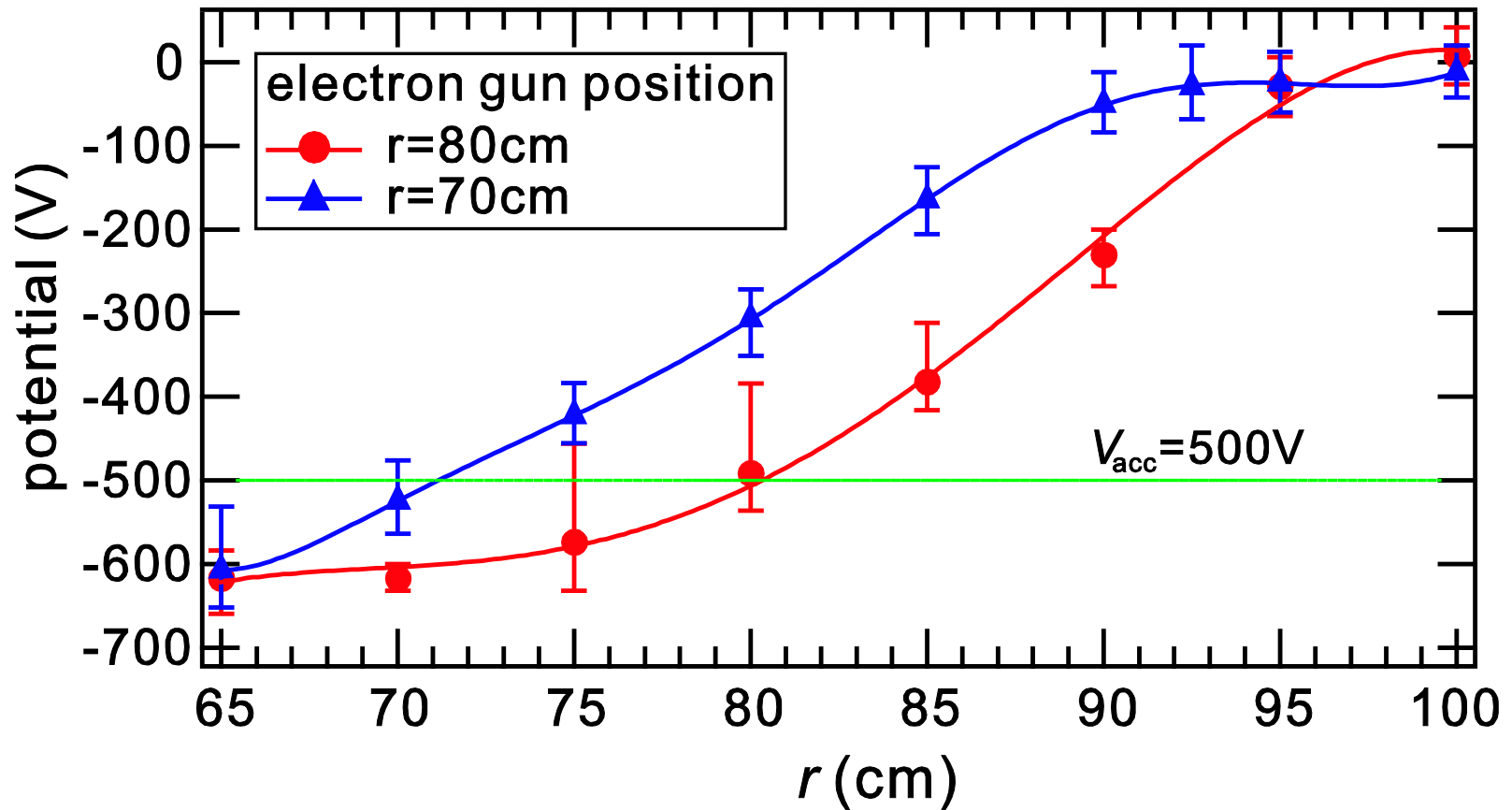

実験のまとめ

- *self-organized confinement* の実証

- 加熱 = 磁気モーメント入射 $\times B$

渦場のメトリック

- 内向き拡散 \rightarrow メトリックの歪みの実証

Summary

- $VORTEX = \text{distorted space-time}$
- effective phase space \rightarrow foliation (Casimir leaf)

Newton-Kant “space” \rightarrow relativity, foliation
and beyond